







band

LAMPADA DA PARETE
Wall lamp | Applique | Wandleuchte

 Lampada da parete biemissione con LED integrato, montatura in metallo verniciato e diffusore in metacrilato bianco.

 Bi-emission wall lamp with integrated LED, painted metal frame and white methacrylate diffuser.

 Applique bi-émission avec LED intégrée, structure en métal peint et diffuseur en méthacrylate blanc.

 Doppelaustrahlungswandleuchte mit integrierter LED-Lampe, lackierter Metallrahmen und Diffusor aus weißem Methacrylat.



BIEMISSIONE
double emission



K-SWITCH
3000K - 4000K

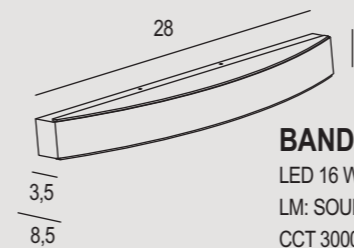

BAND A28

LED 16 Watt
LM: SOURCE 2066 (REAL 1467)
CCT 3000 / 4000 K
IP20
L 28 P 3,5/8,5 H 5 cm

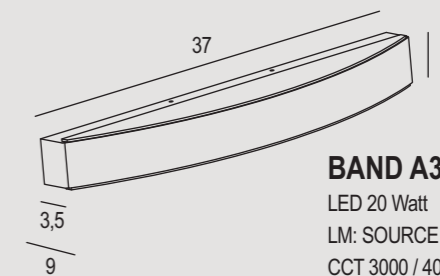

BAND A37

LED 20 Watt
LM: SOURCE 2529 (REAL 2081)
CCT 3000 / 4000 K
IP20
L 37 P 3,5/9 H 5 cm

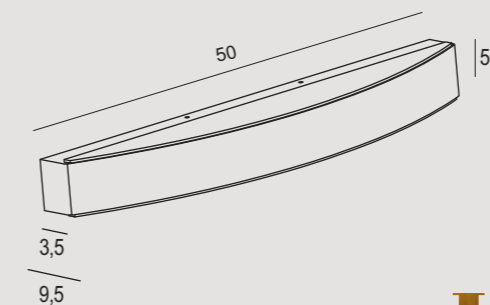

BAND A50

LED 28 Watt
LM: SOURCE 3665 (REAL 2745)
CCT 3000 / 4000 K
IP20
L 50 P 3,5/9,5 H 5,5 cm

J JEWELS RANGE

FINITURE DISPONIBILI | Finishes available

WH	SG	DG	NE	RU	TO	MA
						
Bianco White	Grigio Perla Silver grey	Antracite Dark grey	Nero Black	Ruggine Rust	Tortora Turtledove	Magenta Magenta
GF	SF	RF	MG	BN	MC	VB
						
Foglia oro Gold foil	Foglia Argento Silver foil	Foglia Rame Copper foil	Oro opaco Matt gold	Oro rosato Pink Gold	Rame opaco Matt copper	Verde bosco Forest green

